

SCREENIT A30

DE-MOUNTING AND RECYCLING

COMPONENTS

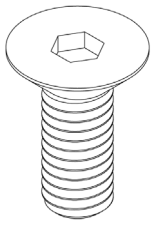

A. Screw*
Material: zinc plated steel

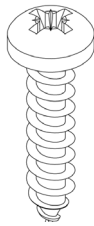

B. Screw*
Material: zinc plated steel

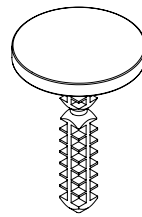

C. Cover plug, 2 pcs
Material: PA

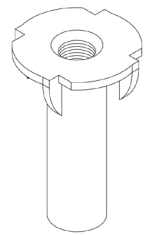

D. Insert nut*
Material: zinc plated steel

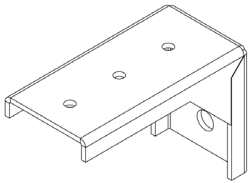

E. Desk mount*
Material: lacquered steel

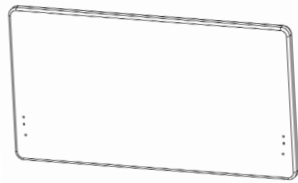

F. Textile cover, 1 pcs
Material: foam laminated textile

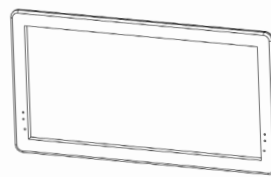

G. Frame, 1 pcs
Material: wood (pine)

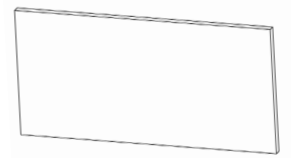

H. Absorbent*
Material: PET

* Amount and appearance can vary.

TOOLS

- Hex key
- Screw driver – PZ2

GOTESSENS

info@gotesson.se | www.gotessons.com | +46 (0)321-68 77 00
Götessons Industri AB, Rönnåsgatan 5B, 523 38 Ulricehamn, Sweden

DE-MOUNTING: STEP BY STEP

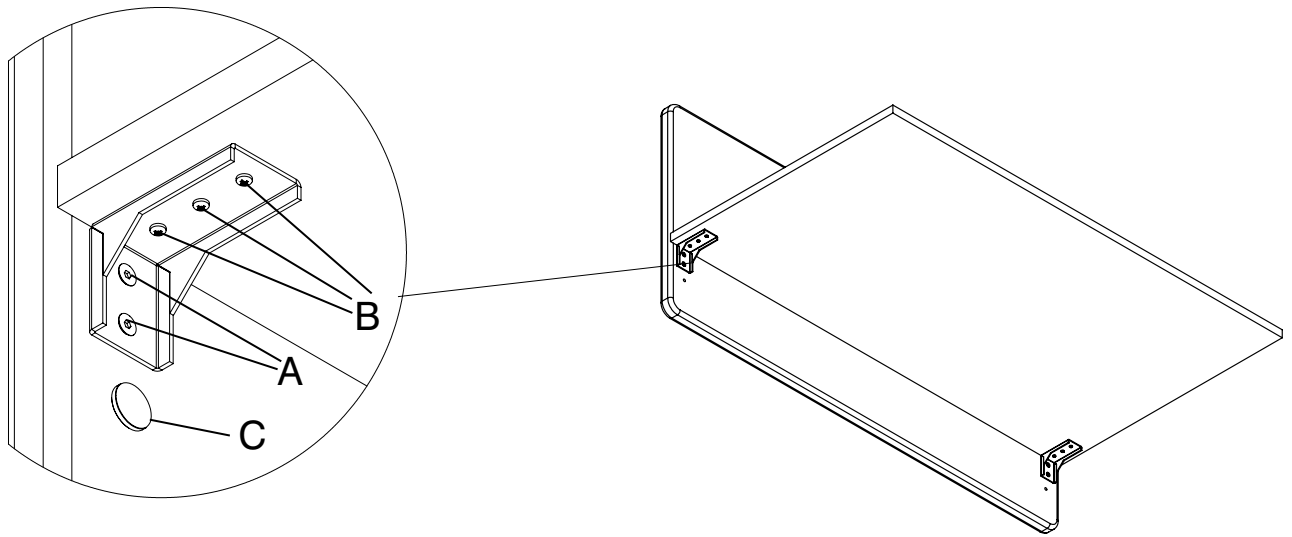

- Unscrew screws (A) from the screen.
- Unscrew screws (B) from the table.
- Remove cover plug (C) from the screen.

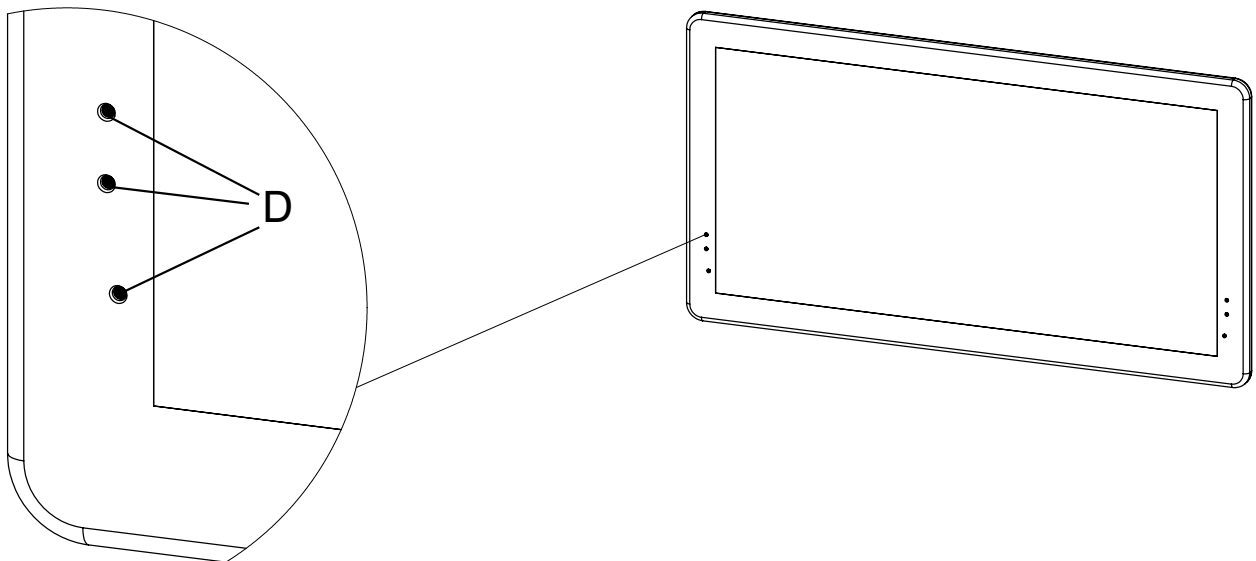

- Open the zip and remove the textile cover (F) from the frame (G).
- Push out the insert nuts (D) from the frame (G).
- Separate the absorbent (H) from the frame (G).

GOTESSONS